

PRODUCT CATALOGUE

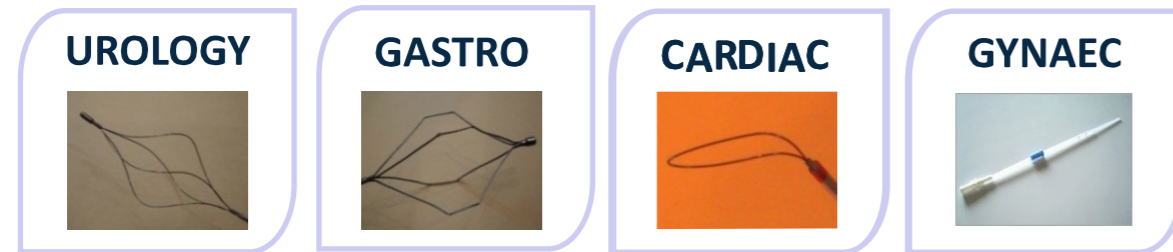

UROLOGY: Stents / Catheters / Baskets etc..

GASTROENTEROLOGY

CARDIOLOGY: Vascular Snare & Baskets

GYNAECOLOGY: IUI Catheters / Cannula

ENDOSCOPY INSTRUMENTS /

URETROSCOPE / CYSTOSCOPE

RESECTOSCOPE / HYSTEROSCOPE

UNIVERSAL MEDICAL DEVICES (FZC)

Q4-204, SAIF ZONE, SHARJAH (UAE)

UAE | MIDDLE EAST | USA | EUROPE | UK | AFRICA
BANGLADESH | NEPAL | BAHRAIN

CONTACT-

+971527284954 / 527220582 / 526583675

www.universalmedicaldevices.com

info@universalmedicaldevices.com

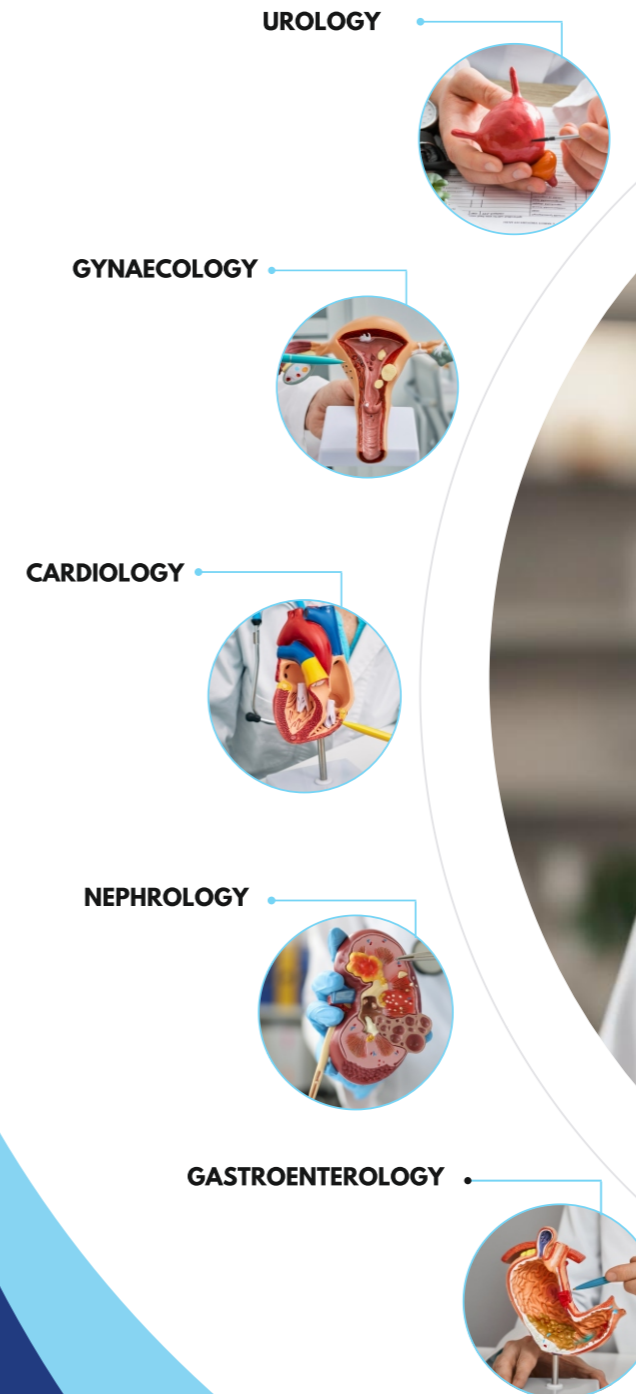

OUR TEAM

Our team at **UNIVERSAL MEDICAL DEVICES (FZC) UAE**, is a dynamic and dedicated group of professionals committed to excellence. With diverse expertise and a collaborative spirit, we work seamlessly to achieve our goals. Each team member brings a unique skill set and passion to contribute to the success of our projects. Our cohesive and innovative approach fosters a positive work environment, driving creativity and delivering exceptional results. Together, we strive for excellence in every endeavor, ensuring the success and growth of UNIVERSAL.



Mr. Mohmedasif Khadimhusain Momin - Director (USA)



Mr. Sajid Dilavar Husen Momin - Director (USA)



Mr. Paresh Bhatt - Director (India / Dubai)



in association with
Mr. Sunil R Shetty - Research & Devt. Expertise (India / Dubai)



Mrs. Swarna Sunil Shetty - Director (Dubai-UAE)



Ms. Prushatha Shetty - Director (Dubai-UAE)

INTRODUCTION

UNIVERSAL MEDICAL DEVICES (FZC) based at Sharjah (UAE), exclusively an OEM based company, supplying in bulk. It is a successful business-to-business Company delivers high quality ENDOSCOPY DISPOSABLES AND INSTRUMENTS and specialised in the fields of UROLOGY, GASTROENTEROLOGY, GYNAECOLOGY, NEPHROLOGY, RADIOLOGY and CARDIOLOGY etc., By using the latest technology, Universal Medical Devices has shown its innovative and open to change mindset, hence adopted the principle of advancing in the sector by rapidly responding to the new and changing needs of its users.

Universal has formed well-established customer relationships over many years through its global sales and service network. Universal provides products that protect, support and save lives. We offer a state-of-art system that sets new standards as a result of its complexity and user-friendliness. We have been devoted to serve the unique and innovative product based on advance technology, which is a vital part of our corporate identity. We are passionate about developing technologies, products, expertise and services for health care industries that help them to achieve their goals since many years. These are our foundations which we build on in the future too.

In order to maintain and further strengthen our market position, we will continue to do everything we can, to optimally align the interests of our corporate partners and importers worldwide. Our products are widely recognised for their high quality design and have been received well globally. We have grown our export business rapidly, with partners in over 65 territories and looking to continue this expansion, seeking many more new international surgical companies and suppliers and distributors.

UNIVERSAL provides quality products at the best prices, making sure that it's partners, importers, suppliers, distributors and dealers make good margins and profit on all our products.

Our contract manufacturing business has been expanding rapidly; supplying clients for several years. We supply/export using a global network of authorised distributors worldwide.

MISSION STATEMENT

Provides an exceptional service by delivering the highest professional standards and we endeavour to exceed expectations. Investing in new technology and product development to maximise efficiency and sustainability of both products and systems.

UNIVERSAL MEDICAL DEVICES continue to grow and succeed in fulfilling the global community's medical needs. Be assured that we will always maintain your continued support and business relationships in the near future too.

UNIVERSAL MEDICAL DEVICES (FZC)

Q4-204, SAIF ZONE, SHARJAH (UAE)



UROLOGY

- STENTS
- CATHETERS
- BASKETS
- AMPLATZ
- DILATORS
- SPDC
- RETRIEVALS
- STONE CONE ENGAGE
- N COMPASS
- LITHOCLAST
- TOMMEY SYRINGE
- ALLYX BOTTLE
- ELLEC EVACUATOR
- PMP MESH

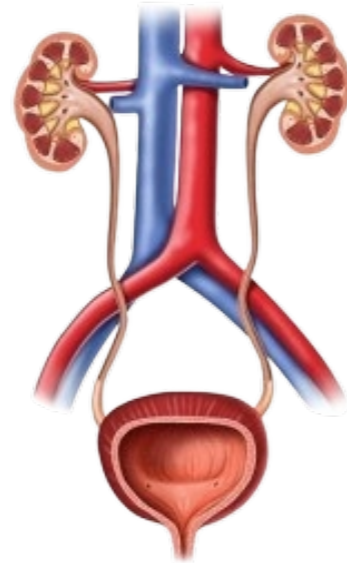

SCAN FOR WEBSITE



INDEX

STENTS -----	
URETERAL INDWELLING D 'J' STENT TECO FLEX	5
D 'J' STENT SET	5
URETERAL INDWELLING D 'J' STENT SILICON	6
CATHETERS -----	
URETERAL	
URETERAL CATHETER	7
PIGTAIL	
PIGTAIL CATHETER	8
PIGTAIL TROCAR	8
PERCUTANEOUS PIGTAIL NEPHROSTOMY CATHETER SET	8
• PIGTAIL CATHETER 23 CM + INITIAL PUNCTURE NEEDLE + GUIDE WIRE + URINE BAG CONNECTOR + FASCIAL DILATORS + CLAMP	
MALECOT	
MALECOT CATHETER	9
MALECOT TROCAR	9
PERCUTANEOUS MALECOT NEPHROSTOMY CATHETER SET	9
• MALECOT CATHETER 25 CM + INITIAL PUNCTURE NEEDLE + GUIDE WIRE + URINE BAG CONNECTOR + FASCIAL DILATORS + SCALPEL	
ENDOURETEROTOMY STENT	10
AMPLATZ -----	
AMPLATZ SHEATH	11
AMPLATZ SHEATH WITH DILATOR	12
RENAL AMPLATZ DILATOR SET	12
• FACIAL DILATOR +RENAL DILATORS + DILATOR WITH AMPLATZ SHEATH + INTRODUCING CATHETER 8FR	
DILATORS -----	
FASCIAL DILATOR SET (SET OF 5 DILATORS)	13
URETHRAL DILATOR SET (SET OF 5 DILATORS)	13
URETERAL DILATOR SET (SET OF 5 DILATORS)	13
MEATAL DILATOR (MALE, FEMALE AND PAEDIATRIC)	14
SPDC -----	
SUPRAPUBIC PUNCTURE AND DRAINAGE SET (LATEX SILICON)	15
• ABS TROCAR, PEEL OFF LDPE SPIGOT SLEEVE, SCALPEL BLADE, PREFERRED FOLEY CATHETER, SPIGOT	
ACCESS SHEATH -----	16
IPN NEEDLE -----	17
TRU-CUT BIOPSY (MANUL / SEMI-AUTOMATIC) -----	18
TURP ELECTRODES 24FR (MONOPOLAR / BI- POLAR) -----	19
PERK BASKET -----	20
PERK BASKET (3LOOP) ANGULAR	21
URS GRASPER - RIGID (TRI-PRONG / BI- PRONG) -----	22

GUIDEWIRES

SS GUIDE WIRE (SS SPRING WITH TEFLON COATED) 23
 SLIDE GUIDEWIRE (NITINOL WITH HYDROPHIL COATED) 23
 STRIP GUIDEWIRE (NITINOL WITH TEFLON JACKET) 23

RETRIVALS

SS RETRIEVAL
 SEGURA / HELICAL 24
 TRI - PRONG GRASPER (FLEXIBLE) 24
 STENT REMOVAL GRASPER (FLEXIBLE) 24
NITINOL RETRIEVALS
 SEGURA / HELICAL 25
 '0' TIP SEGURA / HELICAL 25

STONE CONE

NITINOL STONE CONE 26

ENGAGE

NITINOL STONE EXTRACTOR (3 LOOP) 27

N COMPASS

NITI COMPASS BASKET 28

LASER BASKET

LITHOCLAST

LITHOCLAST ACCESSORIES 31

UROLOGY ACCESSORIES

ENDOSCOPY SYRINGE 32
 BULB EVACUATOR 33
 ALLYX BOTTLE (PVC/ SILICON) 33
 TRACK FINDER - BULB IRRIGATION (SILICON TUBE) 34
 PENILE CLAMP INCONTINENCE CLAMP 35
 UMBILICAL CLAMP 35

MONOFILAMENT POLYPROPYLENE MESH

36

URETERAL INDWELLING D 'J' STENT

Used for temporary internal drainage from the Ureteropelvic junction to the bladder
 * Caution: Periodic evaluation is advised. Stent must not remain indwelling more than 45 days

- * OEO - One end open
- * BEO - Both end open
- * Highly Radiopaque for better visualization
- * Radiopaque Polyurethane
- * Perfect shape to prevent migration of stent
- * Tapered end for easy insertion over guidewire

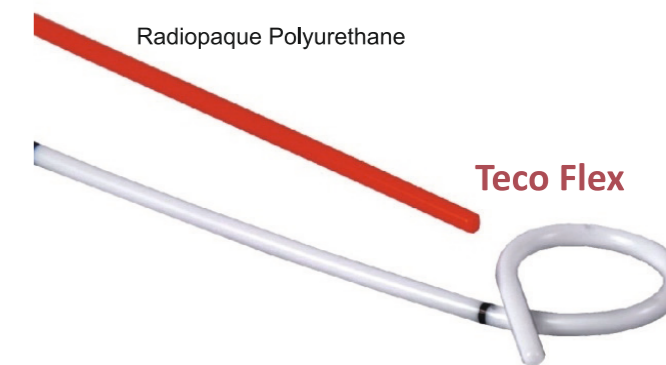

D 'J' STENT SET

* Set combination :
 Stent + Pusher + Guidewire + Clamp

Order Number	Size (French)	Length (cm)	Type	Recommended (Guide Wire)
DJTF6O	6 Fr	22, 24, 26 cm	OPEN END	0.038"
DJTF6C	6 Fr	22, 24, 26 cm	CLOSE END	0.038"
DJTF5O	5 Fr	22, 24, 26 cm	OPEN END	0.035"
DJTF5C	5 Fr	22, 24, 26 cm	CLOSE END	0.035"
DJTF45O	4.5 Fr	16, 18, 20, 22 cm	OPEN END	0.032"
DJTF45C	4.5 Fr	16, 18, 20, 22 cm	CLOSE END	0.032"
DJTF4O	4 Fr	16, 18, 20 cm	OPEN END	0.028"
DJTF4C	4 Fr	16, 18, 20 cm	CLOSE END	0.028"
DJTF35O	3.5 Fr	12, 14, 16, 18 cm	OPEN END	0.025"
DJTF35C	3.5 Fr	12, 14, 16, 18 cm	CLOSE END	0.025"
DJTF3O	3 Fr	12, 14, 16 cm	OPEN END	0.018"
DJTF3C	3 Fr	12, 14, 16 cm	CLOSE END	0.018"
DJTF25O	2.5 Fr	12, 14, 16 cm	OPEN END	----
DJTF25C	2.5 Fr	12, 14, 16 cm	CLOSE END	----

- * Stent with suture can be provided on request
- * Other sizes can be provided on request
- * Long Pusher can be provided on request

URETERAL INDWELLING D 'J' STENT

Used for temporary internal drainage from the Ureteropelvic junction to the bladder
 * Caution: Periodic evaluation is advised.

SILICON blended material Highly Radiopaque for better visualization & very good push ability Can be indwelled in body up to 9 - 12 months



- * O - Both end open
- * Highly Radiopaque for better visualization
- * Perfect shape to prevent migration of stent
- * Tapered end for easy insertion over guidewire

Order Number	Size (French)	Length (cm)	Type	Recommended (Guide Wire)
DJS60	6 Fr	26 cm	OPEN END	0.038"
DJS50	5 Fr	26 cm	OPEN END	0.035"

URETERAL CATHETER

Ureteral Catheters are used to insert into the ureter to prevent obstruction of the urine flow Catheters are made and design by using finest quality polyurethane material

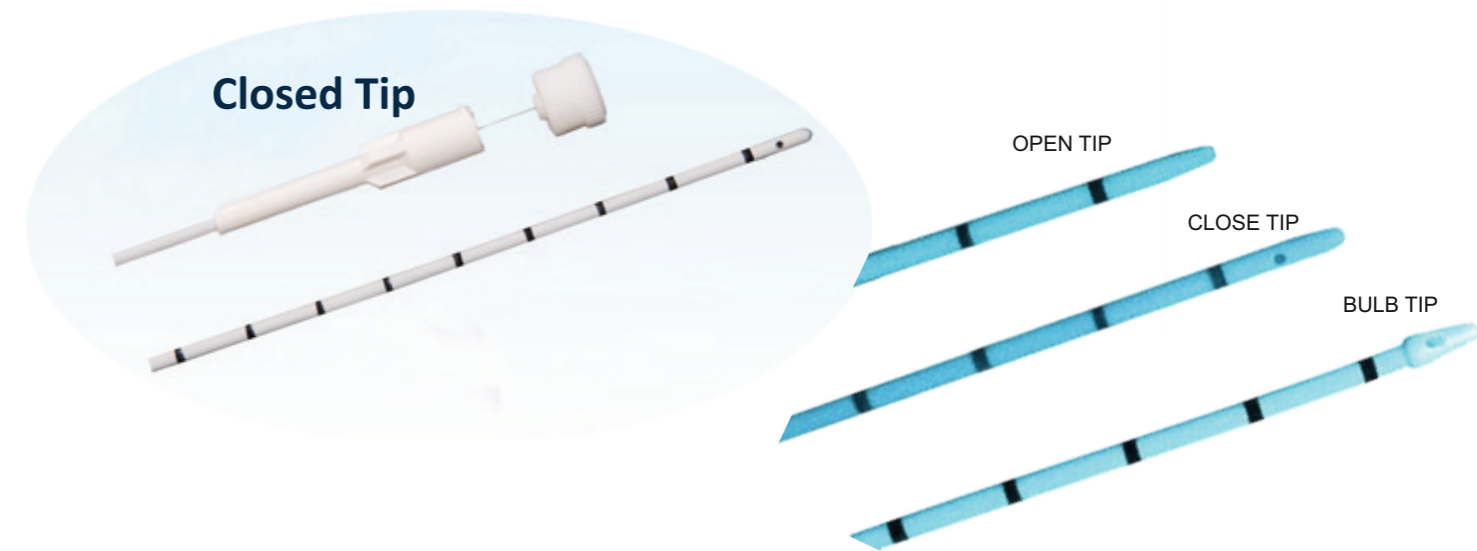

Order Number	Size (French)	Length (cm)	Type	Recommended (Guide Wire)
UC3O	3 Fr	70 cm	OPEN END	0.018"
UC3C	3 Fr	70 cm	CLOSE END	SUPPLIED WITH S S STYLET
UC4O	4 Fr	70 cm	OPEN END	0.025"
UC4C	4 Fr	70 cm	CLOSE END	SUPPLIED WITH S S STYLET
UC5O	5 Fr	70 cm	OPEN END	0.035"
UC5C	5 Fr	70 cm	CLOSE END	SUPPLIED WITH S S STYLET
UC6O	6 Fr	70 cm	OPEN END	0.038"
UC6C	6 Fr	70 cm	CLOSE END	SUPPLIED WITH S S STYLET

* Other sizes can be provided on request

- * O - OPEN END
- * C - CLOSE END
- * BT - BULB TIP

PIGTAIL

Percutaneous Pigtail Nephrostomy Catheter.
Used for temporary drainage of urine from kidney by percutaneous placement, in the presence of distal obstruction.



PIGTAIL CATHETER

Order Number	Size (French)	Length (cm)	Type	Recommended (Guide Wire)
PC 8	8 Fr	30 cm	CATHETER	0.038"
PC 9	9 Fr	30 cm	CATHETER	0.038"
PC 10	10 Fr	30 cm	CATHETER	0.038"
PC 12	12 Fr	30 cm	CATHETER	0.038"
PC 14	14 Fr	30 cm	CATHETER	0.038"

* Supplied with Urine Bag Connector



PIGTAIL TROCAR

Order Number	Size (French)	Length (cm)	Type	Recommended (Guide Wire)
PT 8	8 Fr	25 cm	WITH S S TROCAR	0.038"
PT 10	10 Fr	25 cm	WITH S S TROCAR	0.038"
PT 12	12 Fr	25 cm	WITH S S TROCAR	0.038"
PT 14	14 Fr	25 cm	WITH S S TROCAR	0.038"

* Supplied with 2-part Trocar needle and Urine Bag Connector

Percutaneous Pigtail Nephrostomy Catheter Set

* Pigtail Catheter - 23 cm + Initial Puncture Needle + Guide wire + Urine bag Connector + Fascial Dilators + Clamp

MALECOT

Percutaneous Malecot Nephrostomy Catheter.
Malecot Catheter is placed percutaneously through an existing nephrostomy tract. The radiopaque catheter allows fluoroscopic visualization of the catheter's position.



MALECOT CATHETER

Order Number	Size (French)	Length (cm)	Type	Recommended (Guide Wire)
MI10	10 Fr	30 cm	CATHETER	0.038"
MI12	12 Fr	30 cm	CATHETER	0.038"
MI14	14 Fr	30 cm	CATHETER	0.038"
MI16	16 Fr	30 cm	CATHETER	0.038"
MI18	18 Fr	30 cm	CATHETER	0.038"

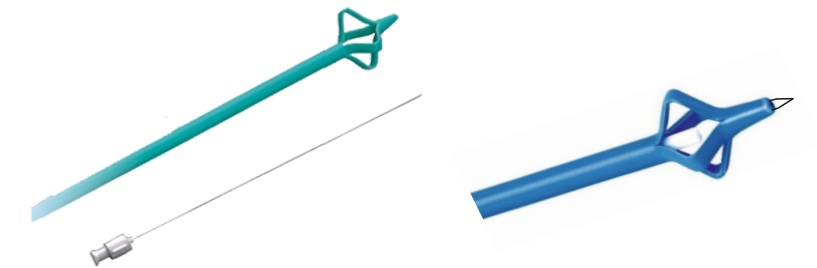

MALECOT TROCAR

Order Number	Size (French)	Length (cm)	Type	Recommended (Guide Wire)
MLT10	10 Fr	25 cm	WITH S S TROCAR	0.038"
MLT12	12 Fr	25 cm	WITH S S TROCAR	0.038"
MLT14	14 Fr	25 cm	WITH S S TROCAR	0.038"
MLT16	16 Fr	25 cm	WITH S S TROCAR	0.038"
MLT18	18 Fr	25 cm	WITH S S TROCAR	0.038"

Percutaneous Malecot Nephrostomy Catheter Set

* Malecot Catheter - 25 cm + Initial Puncture Needle + Guide wire + Urine bag Connector + Fascial Dilators + Scalpel

ENDOURETEROTOMY STENT

Used for temporary internal drainage from the bladder following incision of a stricture. Large diameter at the incised provides optimal healing Soft and flexible for patient comfort.

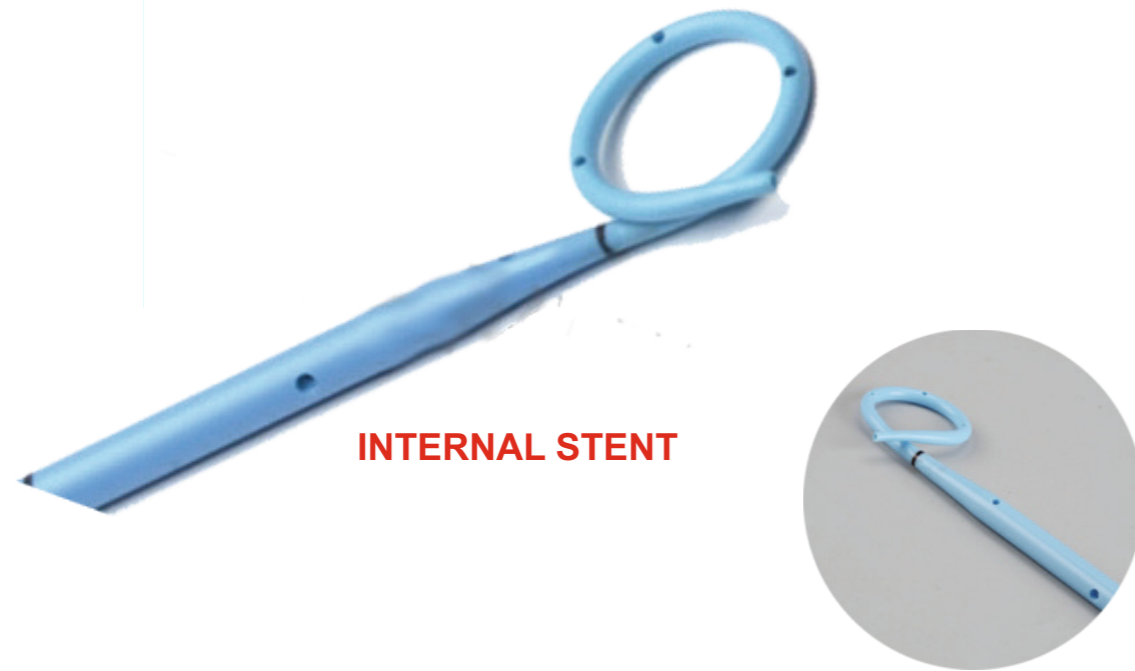

INTERNAL STENT

Order Number	Size (French)	Length (cm)	Type	Recommended (Guide Wire)
EPI 7	7 / 14 Fr	24, 26, 28 cm	OPEN END	0.038"
EPI 6	6 / 12 Fr	24, 26, 28 cm	OPEN END	0.035"
EPI 5	5 / 10 Fr	24, 26, 28 cm	OPEN END	0.032"

*Other sizes can be provided on request

AMPLATZ SHEATH

Amplatz Sheath are sheaths designed to allow smooth passage of surgical instruments into the Nephrostomy tract

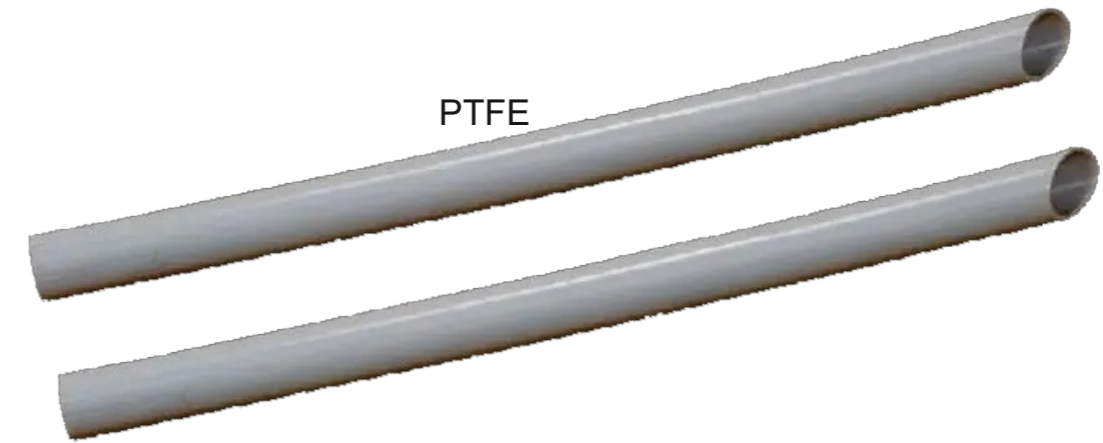

PTFE

Order Number	Size (French)	Length (cm)	Type
AM 16	16 FR	12 cm	PTFE
AM 18	18 FR	12 cm	PTFE
AM 20	20 FR	12 cm	PTFE
AM 22	22 FR	12 cm	PTFE
AM 24	24 FR	12 cm	PTFE
AM 26	26 FR	12 cm	PTFE
AM 28	28 FR	12 cm	PTFE
AM 30	30 FR	12 cm	PTFE
AM 32	32 FR	12 cm	PTFE

* Suffix 'WD' for with Dilator

*Other sizes can be provided on request

AMPLATZ SHEATH WITH DILATOR

Amplatz Sheaths with dilators are designed to allow smooth insertion into the Nephrostomy tract. Intended for nephrostomy tract dilation and the placement of a sheath.



Order Number	Amplatz Size	Dilator Size	Type
AMWD 20	20 FR - 17 cm	16 FR - 30 cm	Amplatz with Dilator
AMWD 22	22 FR - 17 cm	18 FR - 30 cm	Amplatz with Dilator
AMWD 24	24 FR - 17 cm	20 FR - 30 cm	Amplatz with Dilator
AMWD 26	26 FR - 17 cm	22 FR - 30 cm	Amplatz with Dilator
AMWD 28	28 FR - 17 cm	24 FR - 30 cm	Amplatz with Dilator
AMWD 30	30 FR - 17 cm	26 FR - 30 cm	Amplatz with Dilator
AMWD 32	32 FR - 17 cm	28 FR - 30 cm	Amplatz with Dilator
AMWD 34	34 FR - 17 cm	30 FR - 30 cm	Amplatz with Dilator



RENAL AMPLATZ DILATOR SET

RENAL DILATOR SET INCLUDES..

FASCIAL DILATOR 6,8,10 FR - 20 CM

RENAL DILATOR 12,14,16,18,20,22 FR - 30 CM

DILATOR WITH AMPLATZ SHEATH 24,26,28,30 FR - 30 CM
(AMPLATZ SHEATH LENGTH 17 CM)
(DILATOR LENGTH 30 CM)

INTRODUCING CATHETER - 8 FR

Order Number
XDRADS



DILATATION

FASCIAL DILATOR SET * SET OF 5 DILATORS

Used for Fascial dilation

Order Number	Size - Even (French)	Length (cm)	Recommended (Guide Wire)
FD 1	8 - 16 Fr	22 cm	0.038"



URETHRAL DILATOR SET * SET OF 5 DILATORS

Used for dilation of the urethral strictures and to establish and maintain an access into the bladder via urethra



Order Number	Size - Even (French)	Length (cm)	Recommended (Guide Wire)
UTD 1	8 - 16 Fr	36 cm	0.038"

URETERAL DILATOR SET * SET OF 5 DILATORS

Used for dilation of the ureter prior to Ureterscopy procedure

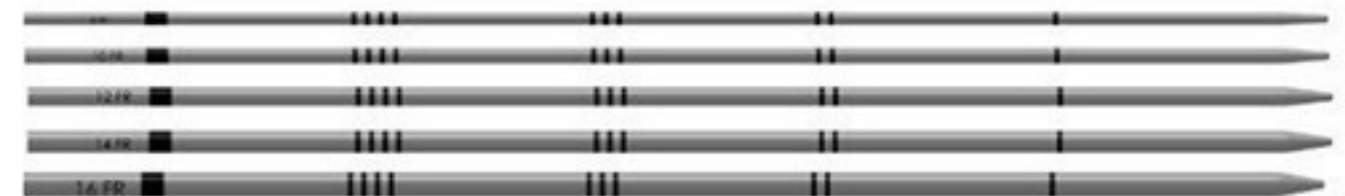

Order Number	Size - Even (French)	Length (cm)	Recommended (Guide Wire)
XDU 1	8 - 16 Fr	70 cm	0.038"

MEATAL DILATOR

Meatal Dilator is used for dilation of the urethral meatus.
The device is colored WHITE and is made of ABS.
Supplied in an individual peel-open package and is intended for single use only.

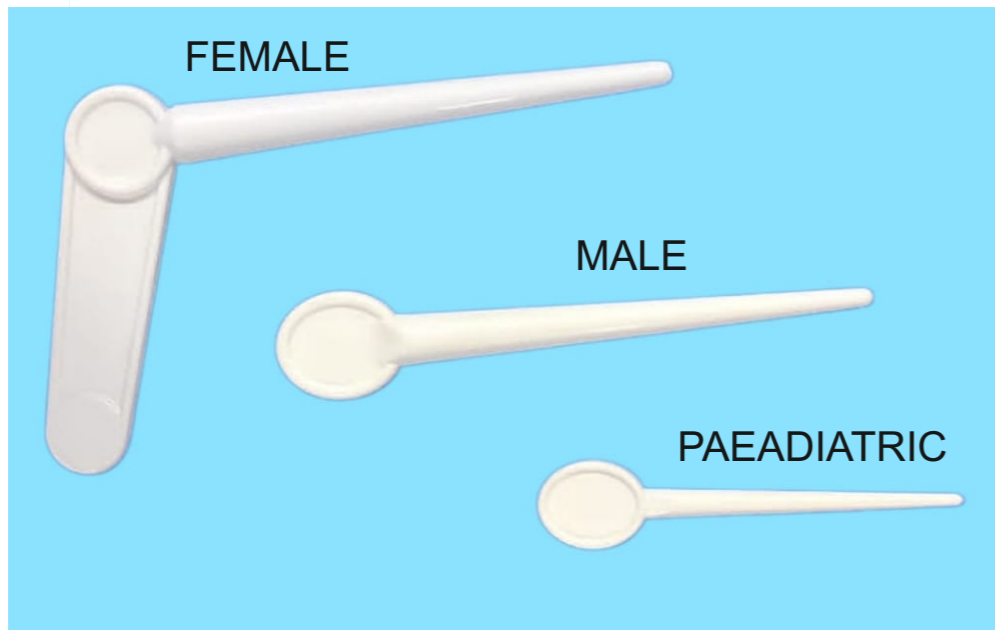

* Other Colors available on request

Order Number	Size	MATERIAL
ML F	FEMALE	ABS - WHITE
ML M	MALE	ABS - WHITE
ML P	PAEDIATRIC	ABS - WHITE

SUPRAPUBIC PUNCTURE AND DRAINAGE SET

(LATEX / SILICON)

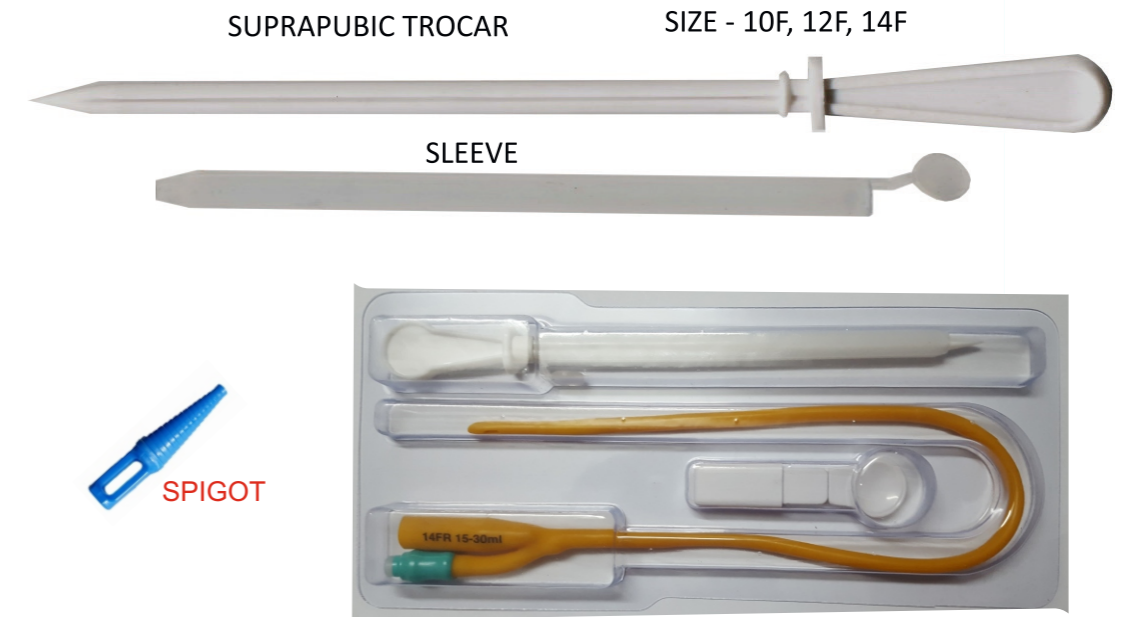

Order Number	Size (French)	FOLEY	Catheter	PEEL OF SHEATH
SPL 8	8 Fr	BALLOON 15-30 ML	LATEX	LDPE
SPS 8	8 Fr	BALLOON 15-30 ML	SILICON	LDPE
SPL 10	10 Fr	BALLOON 15-30 ML	LATEX	LDPE
SPS 10	10 Fr	BALLOON 15-30 ML	SILICON	LDPE
SPL 12	12 Fr	BALLOON 15-30 ML	LATEX	LDPE
SPS 12	12 Fr	BALLOON 15-30 ML	SILICON	LDPE
SPL 14	14 Fr	BALLOON 15-30 ML	LATEX	LDPE
SPS 14	14 Fr	BALLOON 15-30 ML	SILICON	LDPE
SPL 16	16 Fr	BALLOON 15-30 ML	LATEX	LDPE
SPS 16	16 Fr	BALLOON 15-30 ML	SILICON	LDPE
SPL 18	18 Fr	BALLOON 15-30 ML	LATEX	LDPE
SPS 18	18 Fr	BALLOON 15-30 ML	SILICON	LDPE

* Contains: ABS Trocar, Peel off LDPE Sleeve, Scalpel Blade, Preferred Foley Catheter, Spigot

ACCESS SHEATH

Provides Ureteral Dilatation / Continues working Channel for the Introduction of Endoscopes during ureteral access procedures

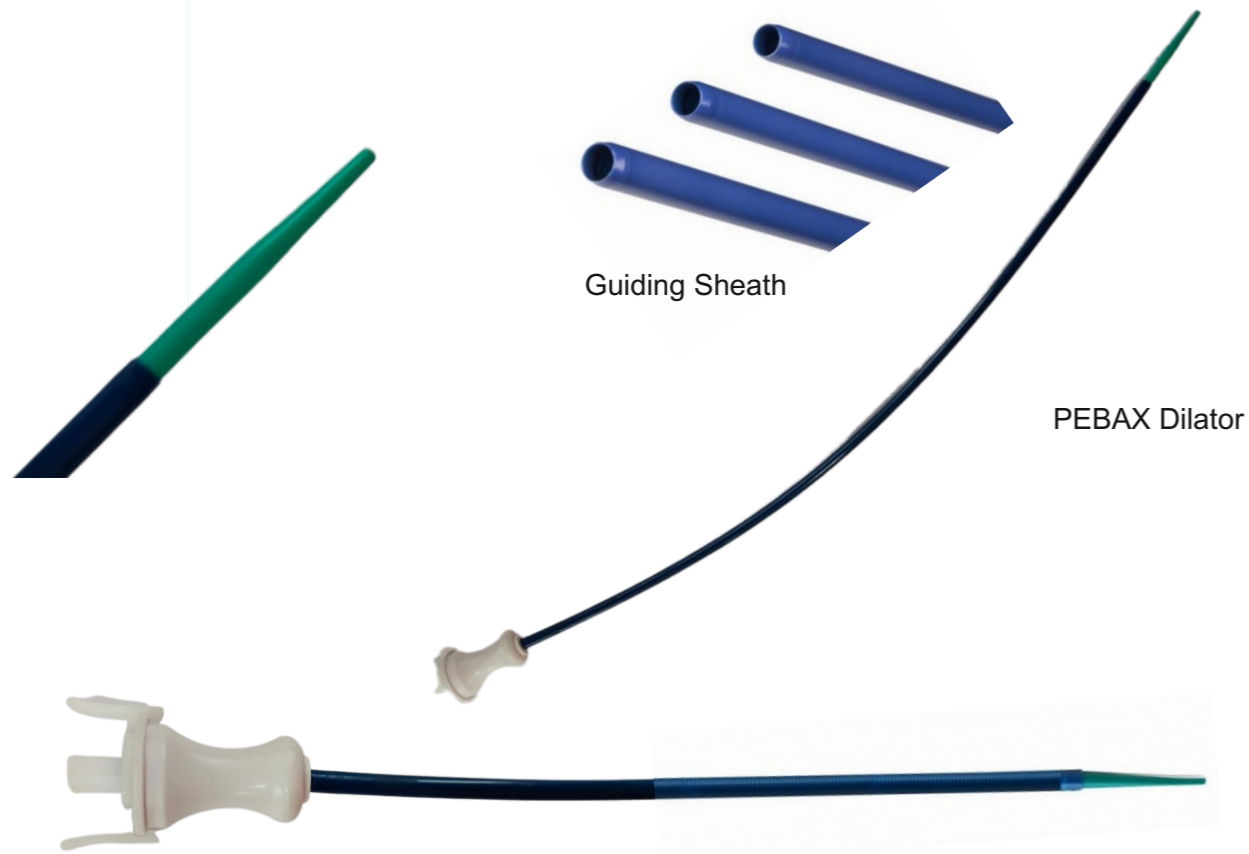

Order Number	Size (French)	Length (cm)	Type	DAILATOR
AS 95	9.5 / 11.5 Fr	35, 45, 55 cm	BRAIDED SHEATH	PEBAX
AS 105	10.5 / 12.5 Fr	35, 45, 55 cm	BRAIDED SHEATH	PEBAX
AS 12	12 / 14 Fr	35, 45, 55 cm	BRAIDED SHEATH	PEBAX

*Other sizes can be provided on request

IPN NEEDLE

Used for Percutaneous Nephrostomy Cyst puncture. Deep tissue access and all other Percutaneous application

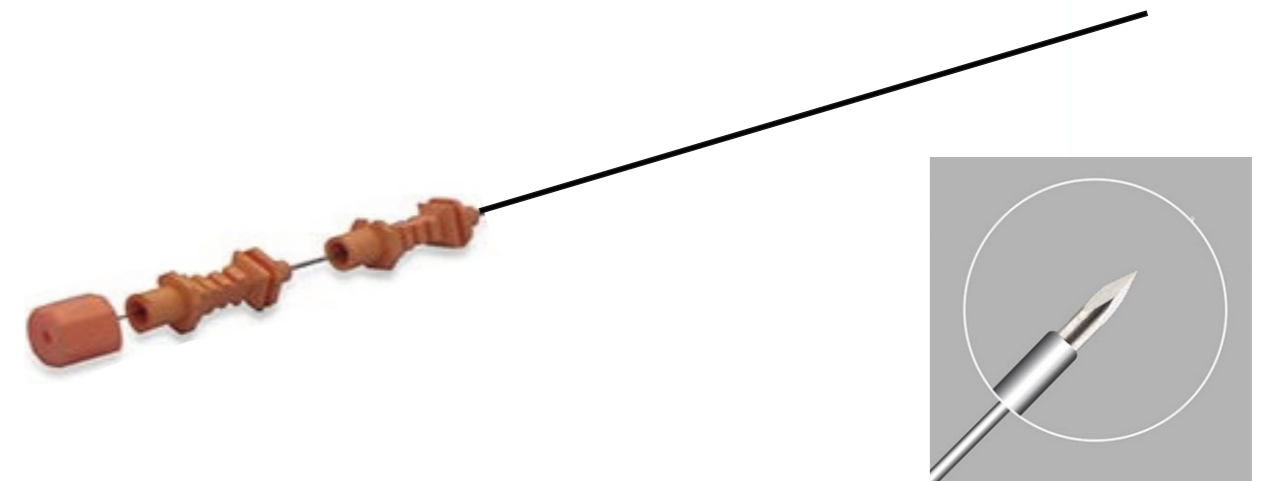

Order Number	Size (Gauge)	Length (cm)	Type	Recommended (Guide Wire)
IPN 11	18 SWG	11 cm	3 PART	0.038"
IPN 15	18 SWG	15 cm	3 PART	0.038"
IPN 18	18 SWG	18 cm	3 PART	0.038"

Diamond & Bevel Tip
 Size : 20G - 2nd Part Needle (Accepts 0.038" Guidewire)
 Used for Nephrostomy Percutaneous applications

TRU-CUT BIOPSY

Tru - cut Biopsy needle: A disposable needle with outer cannula and inner notched rod in which a tissue specimen is cut, trapped and withdrawn. The needle is commonly used for percutaneous biopsy of lymph nodes, liver, kidney, etc.

Feature:

- * 15mm specimen notch
- * Thin-wall needle yields larger core
- * Centimeter depth markings assist in needle placement
- * Irremovable biopsy needle



Order Number	Size (Guage)	Length (cm)	Type	SAMPLING (SIZE)
TRM 20	20 SWG	11, 15, 18 cm	MANUAL	15 MM
TRM 18	18 SWG	11, 15, 18 cm	MANUAL	15 MM
TRM 16	16 SWG	11, 15, 18 cm	MANUAL	15 MM
TRM 14	14 SWG	11, 15, 18 cm	MANUAL	15 MM



Feature:

- * Semi automatic shot
- * 10 - 22mm specimen notch
- * Thin - wall needle yields larger core
- * Centimeter depth markings assist in needle placement

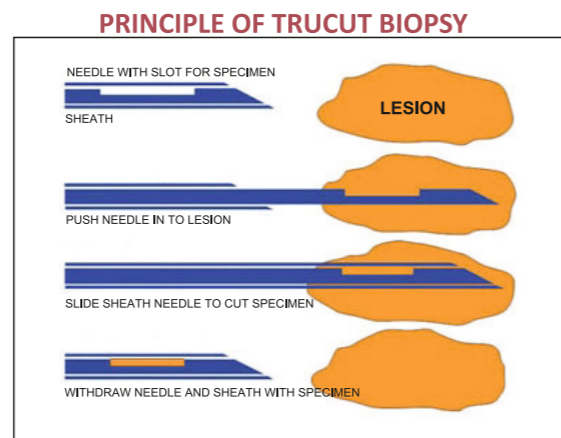

Order Number	Size (Guage)	Length (cm)	Type	SAMPLING (SIZE)
TRS 20	20 SWG	11, 15, 18 cm	SEMI AUTOMATIC	10 - 22 MM
TRS 18	18 SWG	11, 15, 18 cm	SEMI AUTOMATIC	10 - 22 MM
TRS 16	16 SWG	11, 15, 18 cm	SEMI AUTOMATIC	10 - 22 MM
TRS 14	14 SWG	11, 15, 18 cm	SEMI AUTOMATIC	10 - 22 MM

TRUP ELECTRODES 24 Fr

* TURP Electrodes compatible with Karlstorz, Richard Wolf, Olympus working

Monopolar / Bi-polar

DOUBLE STEM CUTTING LOOP
SINGLE STEM CUTTING LOOP
DOUBLE STEM ROLLE(3 / 5 MM)
SINGLE STEM ROLLER(3 / 5 MM)

DOUBLE STEM KOLLINS KNIFE
SINGLE STEM KOLLINS KNIFE
DOUBLE STEM COLD KNIFE



Order Number	Size (French)	Type
MST	24 Fr	LOOP - 1 STEM
BST	24 Fr	LOOP - 2 STEM
MSR	24 Fr	ROLLER 3 MM / 5 MM
MSB	24 Fr	BALL 3 MM / 5 MM
MSCK	24 Fr	COLLINS KNIFE
MSK	24 Fr	COLD KNIFE

PERK BASKET - NITI '0' TIP

Used for the extraction of stones and foreign objects in the kidney and bladder
 The Nitinol wire construction allows the extractor to retain its shape following torsion. A stainless steel cannula provides strength and reliability comparable to traditional reusable surgical instrumentation

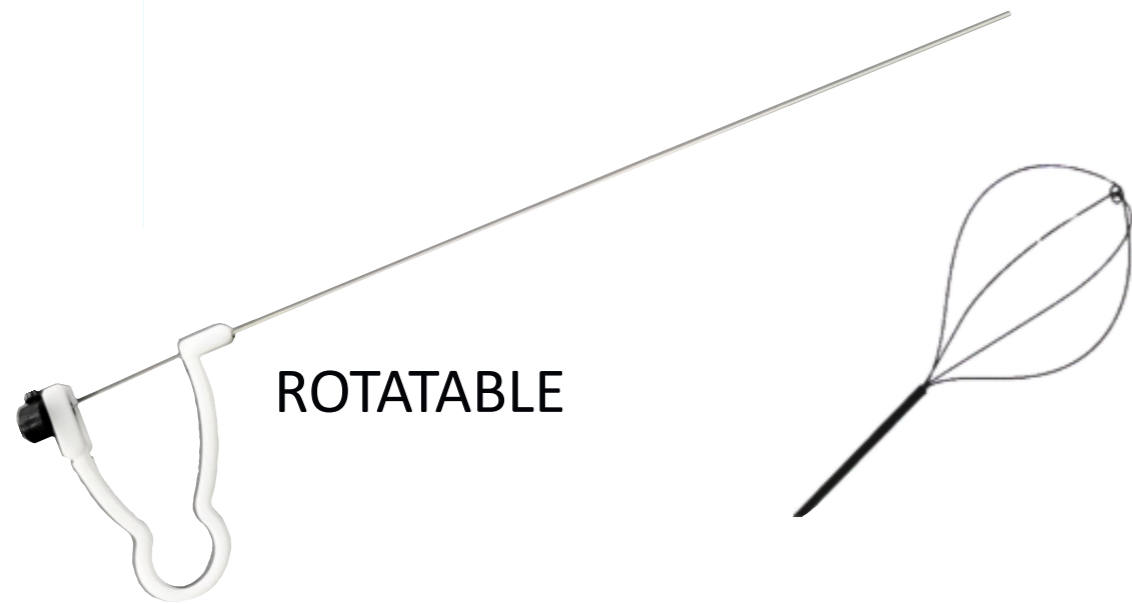

Order Number	Size (MM)	Length (cm)	Sheath / Type	Basket (Configuration)
PB 15	1.5 MM	25, 30, 36 cm	S S / RIGID	4 wire '0' Tip
PB 20	2.0 MM	25, 30, 36 cm	S S / RIGID	4 wire '0' Tip
PB 25	2.5 MM	25, 30, 36 cm	S S / RIGID	4 wire '0' Tip
PB 35	3.5 MM	25, 30, 36 cm	S S / RIGID	4 wire '0' Tip

*Other sizes can be provided on request

PERK BASKET (3 LOOP) ANGULAR

Used for the extraction of stones and foreign objects in the kidney and bladder

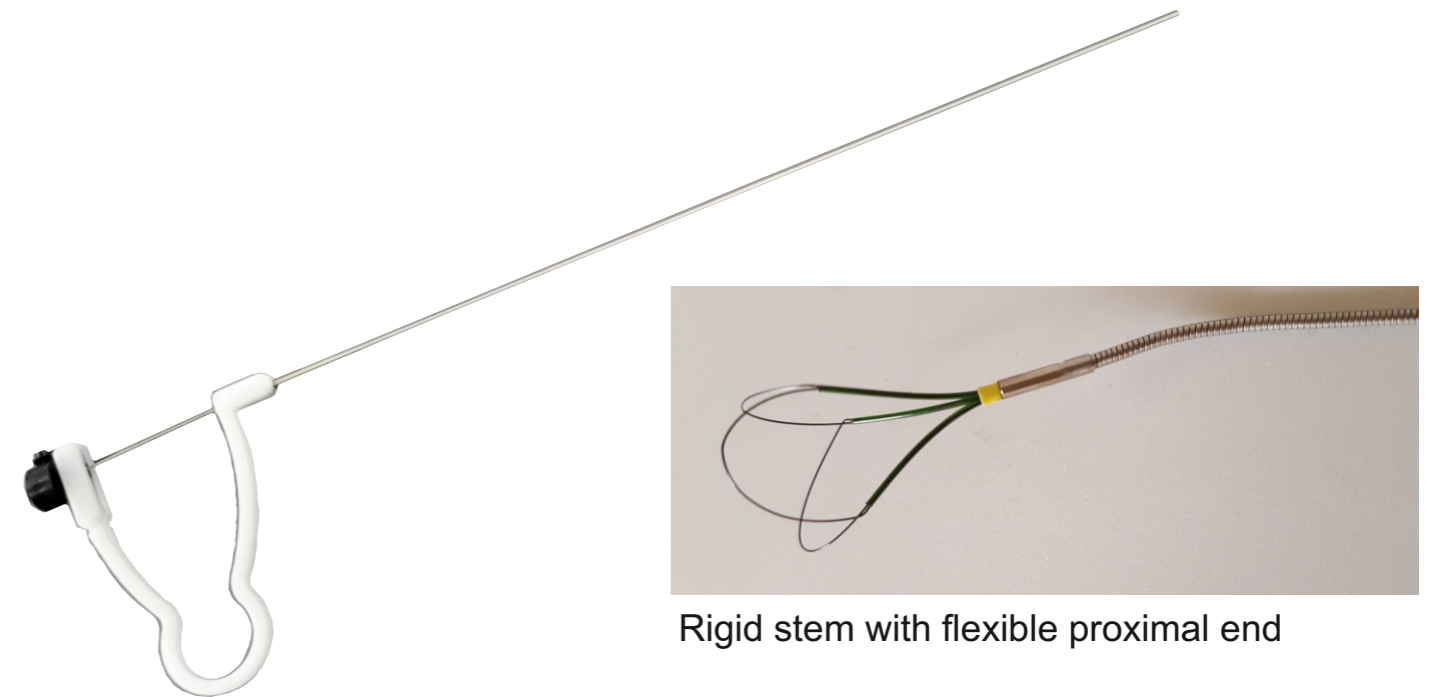

- Nitinol Stone Extractor for ureteral stone extraction
- The design allows you to engage, reposition, release, and extract stones of various sizes throughout the urinary tract
- The Loop of the basket is highly flexible, kink resistant, and durable
- A combination that makes it is the optimal stone retrieval device for multiple clinical applications

Order Number	Size (MM)	Length (cm)	Sheath / Type	Basket (Configuration)
PBL 2	2 MM	25, 30, 36 cm	S S / RIGID ANGLE	3 LOOP
PBL 25	2.5 MM	25, 30, 36 cm	S S / RIGID ANGLE	3 LOOP
PB 3	3 MM	25, 30, 36 cm	S S / RIGID ANGLE	3 LOOP

*Other sizes can be provided on request

URS GRASPER - RIGID

Primarily used for the retrieval of fragmented stones from ureteral and renal pelvis after performing Lithoclast procedure



Order Number	Size (French)	Length (CM)	Sheath	Type
URST 3	3 Fr	45, 60 CM	S S RIGID	TRI - PRONG
URSB 3	3 Fr	45, 60 CM	S S RIGID	BI - PRONG
URST 4	4 Fr	45, 60 CM	S S RIGID	TRI - PRONG
URSB 4	4 Fr	45, 60 CM	S S RIGID	BI - PRONG
URST 5	5 Fr	45, 60 CM	S S RIGID	TRI - PRONG
URSB 5	5 Fr	45, 60 CM	S S RIGID	BI - PRONG

*Other sizes can be provided on request

GUIDE WIRES

Guide wires are intended to facilitate the placement of endo urological instruments during diagnostic or interventional procedures. Used for gaining access and navigating tortuous urinary tract.

S S GUIDE WIRES (S S SPRING WITH TEFLON COATED)

Order Number	Size (Inch)	Length (cm)	SHAPE	TYPE
PG 18	0.018"	150 cm	S / J TIP	PTFE
PG 25	0.025"	150 cm	S / J TIP	PTFE
PG 32	0.032"	150 cm	S / J TIP	PTFE
PG 35	0.035"	150 cm	S / J TIP	PTFE
PG 38	0.038"	150 cm	S / J TIP	PTFE

SLIDE GUIDE WIRES (NITINOL WITH HYDROPHIL COATED)

Order Number	Size (Inch)	Length (cm)	SHAPE	TYPE
PG 25	0.025"	150 cm	S / A TIP	HYDROPHILIC
PG 32	0.032"	150 cm	S / A TIP	HYDROPHILIC
PG 35	0.035"	150 cm	S / A TIP	HYDROPHILIC
PG 38	0.038"	150 cm	S / A TIP	HYDROPHILIC

STRIPE GUIDE WIRES (NITINOL WITH TEFLON JACKET)

Order Number	Size (Inch)	Length (cm)	SHAPE	TYPE
SG 25	0.025"	150 cm	S TIP	TEFLON JACKET
SG 35	0.035"	150 cm	S TIP	TEFLON JACKET
SG 38	0.038"	150 cm	S TIP	TEFLON JACKET

*AVAILABLE HYDRO TIP STRIPE GUIDE WIRE

A - ANGLE
S - STRAIGHT
J - J TIP



SS RETRIEVAL

Stone Basket: Used for the manipulation and removal / retrieval of ureteral stones from the bladder, renal pelvis & ureter

SEGURA / HELICAL

Order Number	Size (French)	Length (cm)	Type	SHAPE
SB 25	2.5 Fr	70, 90, 120 cm	OCCLUSIVE TIP	SEG / HEL
SB 3	3 Fr	70, 90, 120 cm	OCCLUSIVE TIP	SEG / HEL
SB 4	4 Fr	70, 90, 120 cm	OCCLUSIVE TIP	SEG / HEL
SB 5	5 Fr	70, 90, 120 cm	OCCLUSIVE TIP	SEG / HEL

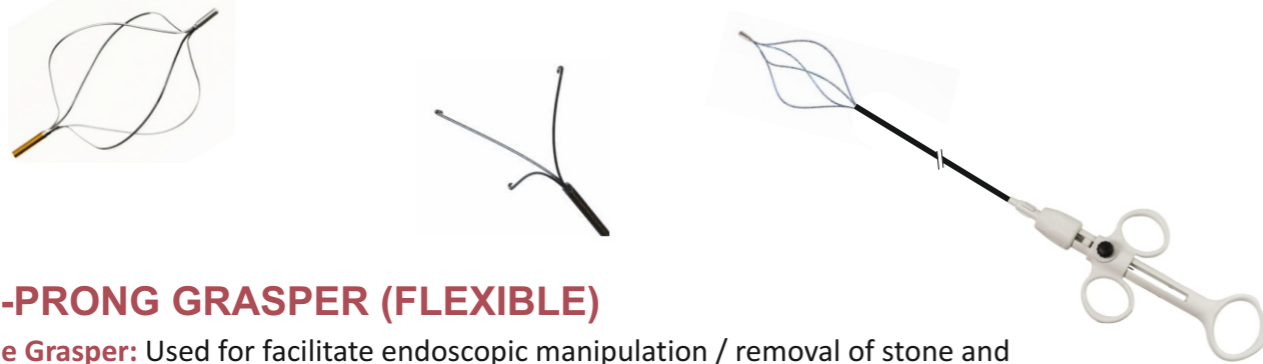

TRI-PRONG GRASPER (FLEXIBLE)

Stone Grasper: Used for facilitate endoscopic manipulation / removal of stone and retrieval of foreign object

Order Number	Size (French)	Length (cm)	Type
SG 3	3 Fr	70, 90, 120 cm	3 - PRONG
SG 4	4 Fr	70, 90, 120 cm	3 - PRONG
SG 5	5 Fr	70, 90, 120 cm	3 - PRONG

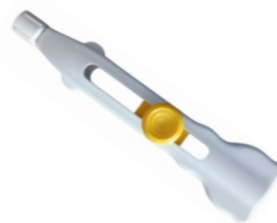

STENT REMOVAL GRASPER (FLEXIBLE)

Designed to remove stents and foreign objects under direct vision - length - 45, 55 cm

Order Number	Size (French)	Length (cm)	Type
SS 3	3 Fr	45, 55 cm	3 - PRONG
SS 4	4 Fr	45, 55 cm	3 - PRONG



NITINOL RETRIEVALS

Super Elastic: Black Oxide Bright NITINOL WIRES, Used for Stone manipulation and retrieval / removal of Ureteral Stones from Bladder, Renal Pelvic and Ureter

SEGURA / HELICAL

Order Number	Size (French)	Length (cm)	Type	SHAPE
NBS 22	2.2 Fr	70, 90, 120 cm	OCCLUSIVE TIP	SEGURA
NBS 25 / NBH 25	2.5 Fr	70, 90, 120 cm	OCCLUSIVE TIP	SEG / HEL
NBS 3 / NBH 3	3 Fr	70, 90, 120 cm	OCCLUSIVE TIP	SEG / HEL
NBS 4 / NBH 4	4 Fr	70, 90, 120 cm	OCCLUSIVE TIP	SEG / HEL

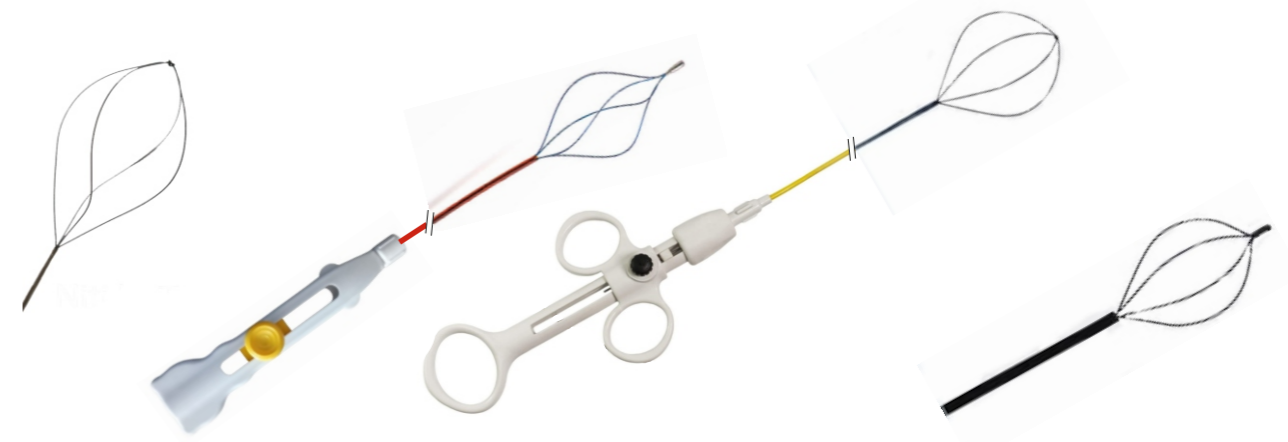

'0' TIP SEGURA / HELICAL

Order Number	Size (French)	Length (cm)	Type	SHAPE
NBS 015	1.5 Fr	70, 90, 120 cm	NON OCCLUSIVE TIP	SEGURA
NBS 018	1.8 Fr	70, 90, 120 cm	NON OCCLUSIVE TIP	SEGURA
NBS 019	1.9 Fr	70, 90, 120 cm	NON OCCLUSIVE TIP	SEGURA
NBS 020	2.0 Fr	70, 90, 120 cm	NON OCCLUSIVE TIP	SEGURA
NBS 022	2.2 Fr	70, 90, 120 cm	NON OCCLUSIVE TIP	SEGURA
NBS 025 / NBH 025	2.5 Fr	70, 90, 120 cm	NON OCCLUSIVE TIP	SEG / HEL
NBS 03 / NBH 03	3 Fr	70, 90, 120 cm	NON OCCLUSIVE TIP	SEG / HEL
NBS 04 / NBH 04	4 Fr	70, 90, 120 cm	NON OCCLUSIVE TIP	SEG / HEL

NITINOL STONE CONE

Designed to prevent stone migration during lithotripsy
 Preventing Retropulsion of stones up the ureter and into the kidney
 Cone Coil is made with Super elastic Nitinol core wire and Soft spring
 Provided Capsule Handle for better grip

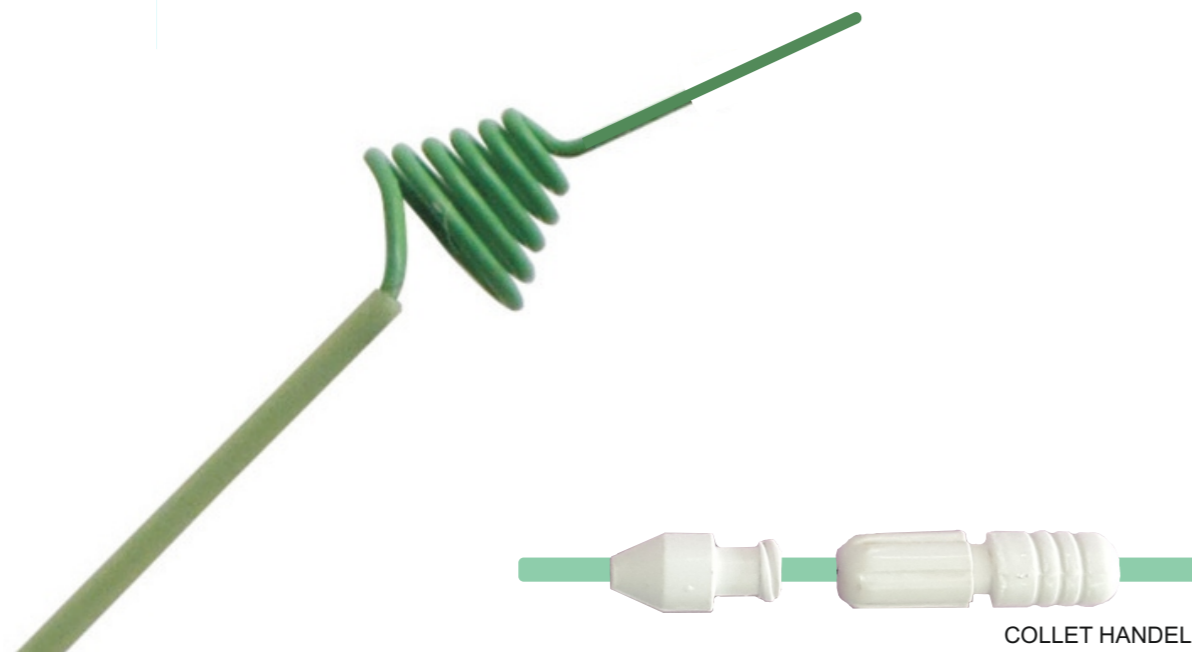

Order Number	Size (French)	Length (cm)	Type	Dimensions (Cone)
NSC 38	3 Fr	90, 115 cm	Cone Coil	8 MM Coil
NSC 310	3 Fr	90, 115 cm	Cone Coil	10 MM Coil

*Other sizes can be provided on request

NITINOL STONE EXTRACTOR (E Ngage)

Nitinol 3-Loop extractor is designed to secure and grip kidney or ureteral stones firmly and also extract and release stones easily, enabling urologists greater control during stone retrieval procedures.

Basket allows physicians to easily engage, release and extract stones even in the most difficult anatomy while providing improved irrigation, visibility and enhanced efficiency.

Retention strength was also demonstrated to be more stronger than traditional Graspers

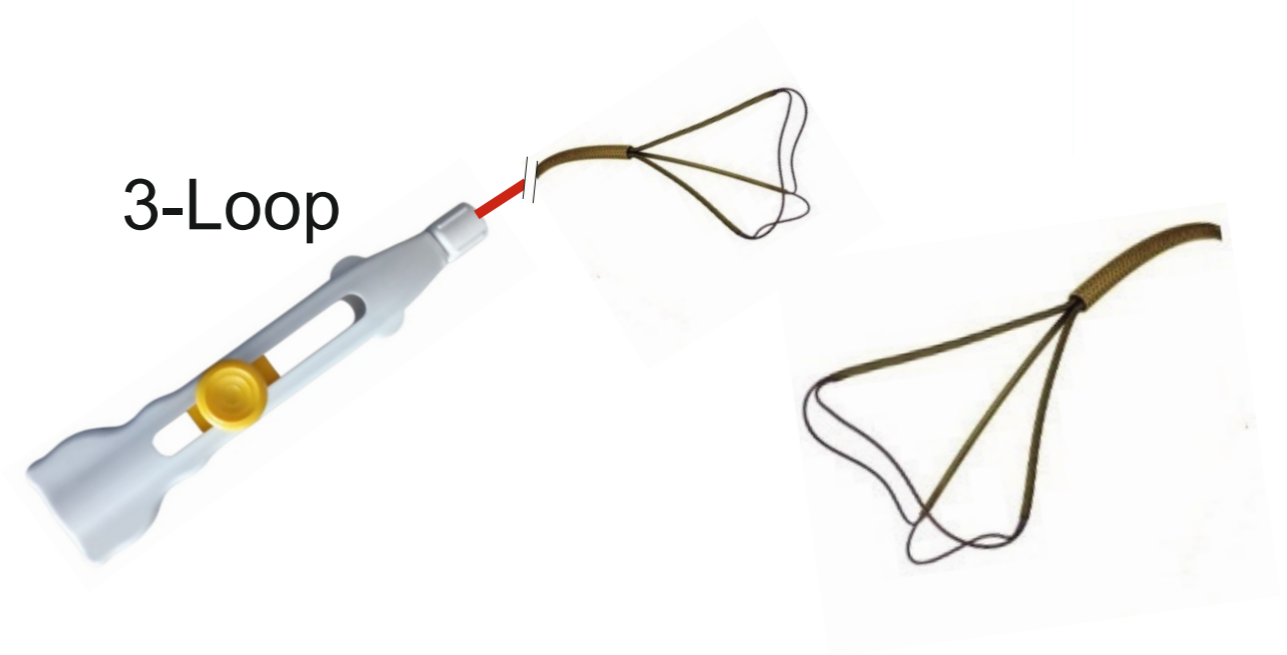

Order Number	Size (French)	Length (cm)	Type
NG 19	1.9 Fr	115 cm	3 - LOOP
NG 25	2.5 Fr	115 cm	3 - LOOP
NG 3	3 Fr	115 cm	3 - LOOP

*Other Lengths can be provided on request

NITI COMPASS BASKET

Compass Nitinol Stone Extractor is used for stone manipulation and removal in the urinary tract. The extractors are supplied sterile in peel-open packages.

Multiwire geometry construction encompasses the stones for secure capture and extraction.

Distal portion of the basket captures the stones as the basket is withdrawn through the ureter, preventing stone migration.

Extraction of intact stones as well as an improved ability to capture multiple small fragments following intra corporeal lithotripsy.

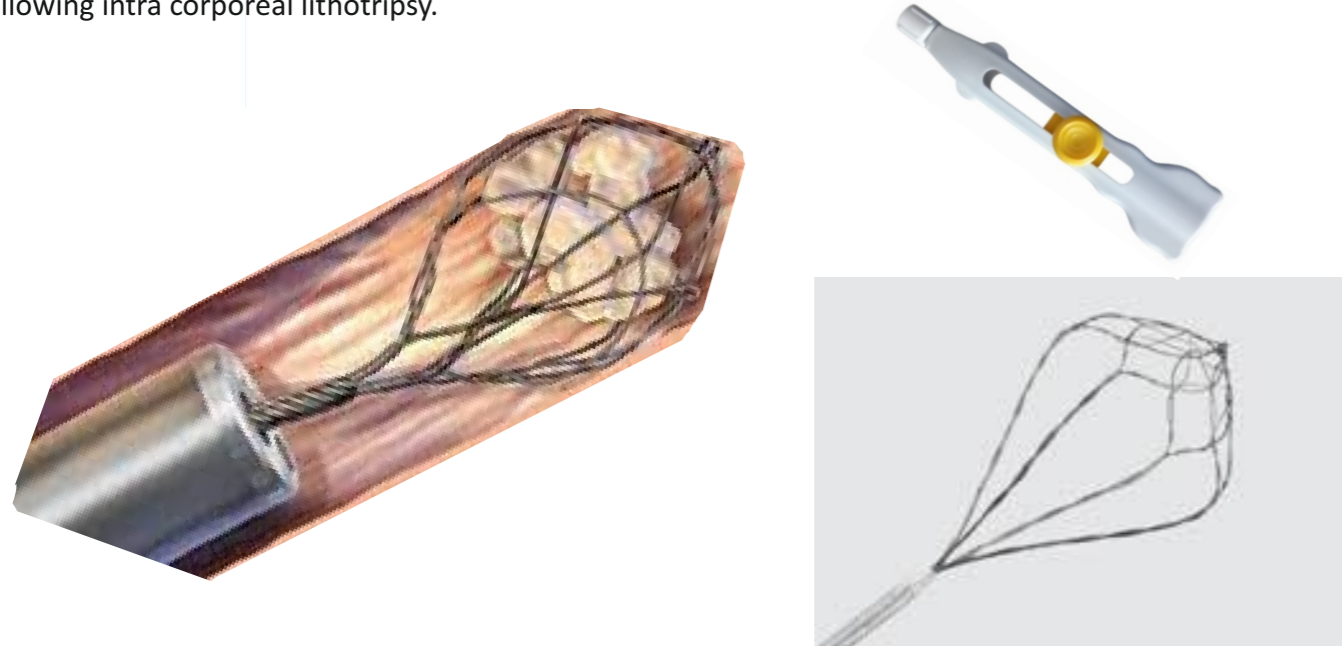

Order Number	Size (French)	Length (cm)	Configuration Basket	Type
CFN 3	3 Fr	90, 110 cm	4 W / 8 W	'0' TIP
CFN 4	4 Fr	90, 110 cm	4 W / 8 W	'0' TIP

*Other sizes can be provided on request

LASER BASKET

Laser Baskets are perfectly designed and developed to use with the Laser Fiber upto 380 micron to blast the stone with the one step procedure, as the Basket Sheath will accept both the laser fiber and Basket together

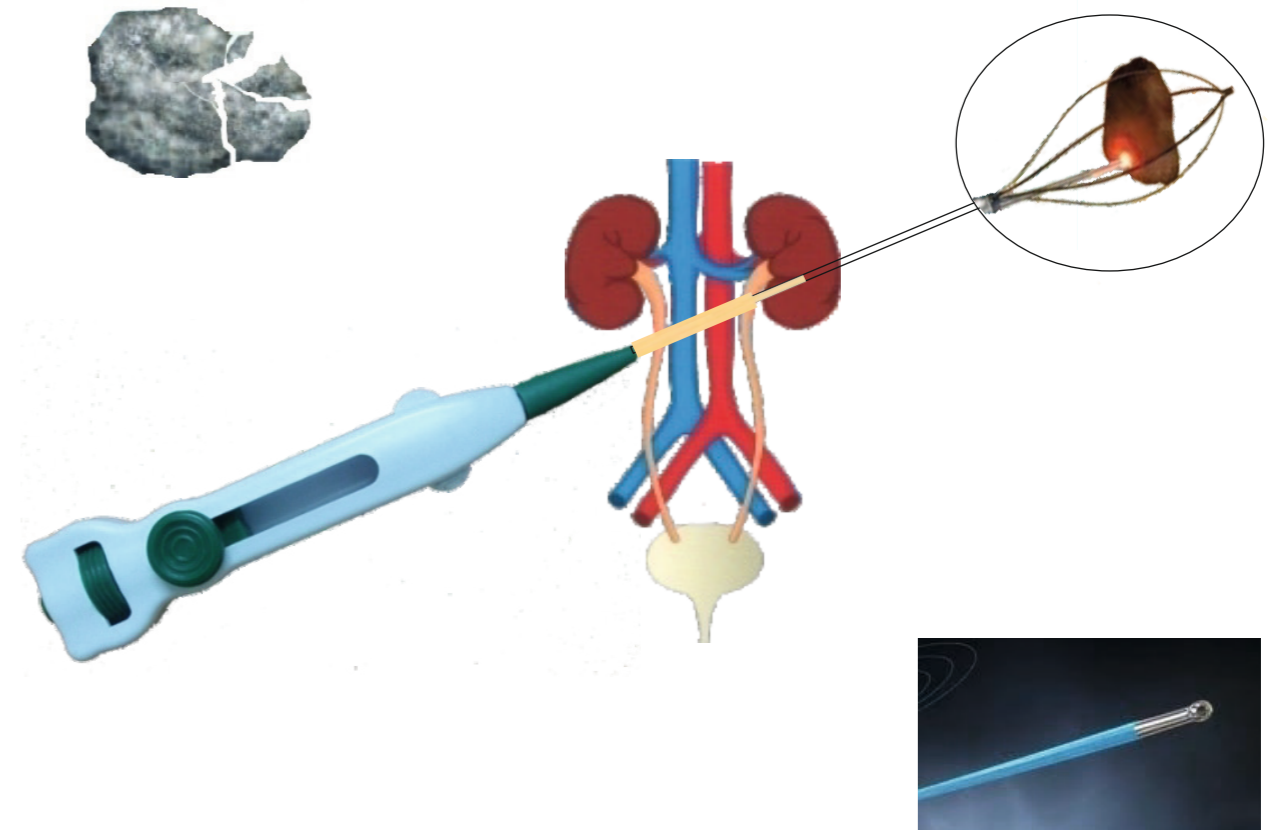

Order Number	Size (French)	Length (cm)	Type	Recommend (Fiber)
LB 25	2.5 Fr	115 cm	NITI '0' TIP	150 <i>um</i>
LB 3	3 Fr	115 cm	NITI '0' TIP	270 <i>um</i>
LB 35	3.5 Fr	115 cm	NITI '0' TIP	360 <i>um</i>

*Other Lengths can be provided on request

LITHO

Technical Specification

Supply Voltage	230 VA/ 50Hz+ 10 % / 110 VA C @60 Hz-t 10 %	
Power Consumptions	30 Watts	
Input Gas	Oxygen / Compressed Dry Air	
In Let Pressure (Minimum)(To Control Unit)	3 BAR	
In Let Pressure (Maximum)(To Control Unit)	6 BAR	
Out Let Pressure Indication	by Digital display	
Freq. of Impacts	Single Pulse Mode, Continuous Pulse Mode with 3 selectable options	
Control Unit (Made from MS Powder coat body)	Size : L 270mm X W 230mm X H 140mm Weight : 3290 gms	
Hand Piece (Made from Aluminum Alloy)	Weight : 180 gms	
Probe (Made from S.S. Alloy-as per ISO-10993 standard		
Ureterorenoscopy Probe	Size: 0.8mm, 1mm, 1.2mm	Length: 610mm
PCNL Probe	Size: 2.0mm	Length: 450mm
Lithobridge Probe	Size: 1.5mm	Length: 460mm

LITHO CLAST



- | | | |
|---|---------------------------------------|--|
| BLASTLITH control unit (01) | Hand piece (02) | Foot switch (01) |
| Soft PU Air tubing to connect with hand piece (01) | Probes (06) | Suction Adopter PCNL Probe (01) |
| Air tubing to connect with control unit (01) | Protection cap hand piece (01) | Mains cable (01) |
| | Handle Guide (01) | |

LITHO ACCESSORIES



SOURCE OF COMPRESSED AIR: This electro pneumatic device requires the supply of continuous, quiet, clean and dry air pressure. The air source can be procured by three ways i.e. Air compressor, Central Oxygen System, Oxygen Cylinder

CENTRAL OXYGEN SYSTEM: The unit can also be placed on central oxygen system in the hospitals or institutions which can provide the normal pressure to activate the system

ACCESSORIES-UROLOGY

ENDOSCOPY SYRINGE

50 ml , 100 ml Glass Syringe

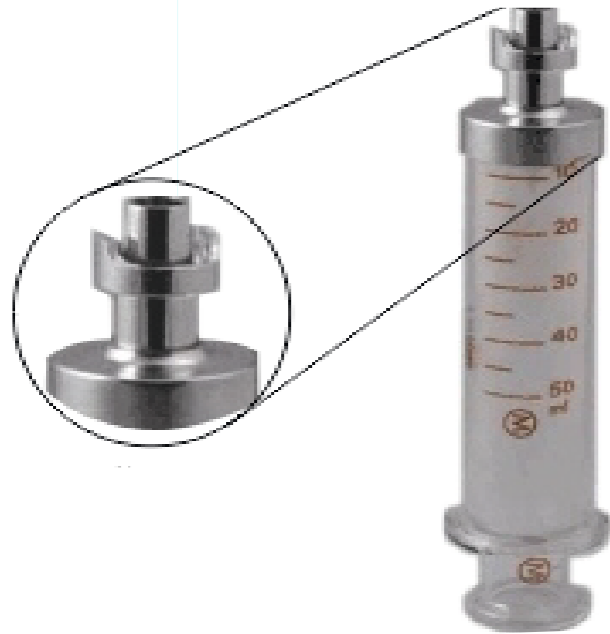

Endoscopy Syringe

Toomey Syringe



5 ml Glass Syringe



ACCESSORIES-UROLOGY

BULB EVACUATOR

For Bladder evacuation during TURP
Adaptor connects to KS / RW / ACMI



ALLYX BOTTLE

PVC



SILICON



ACCESSORIES-UROLOGY

TRACK FINDER - BULB IRRIGATION

Continuous flow with minimal tubing
Compresses in various hand held position

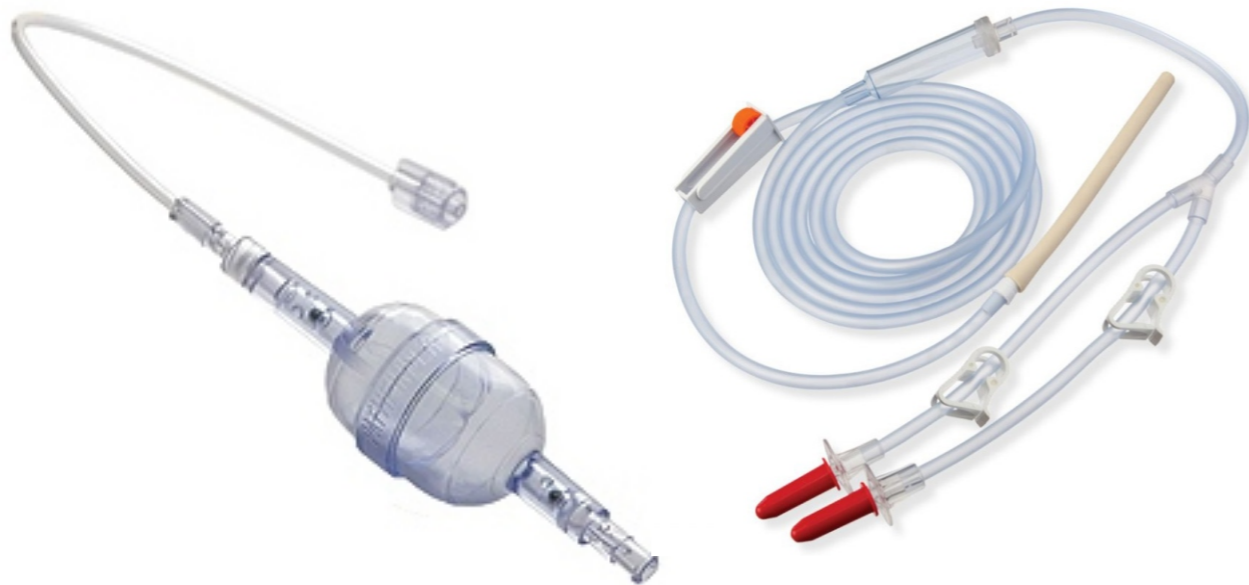

SILICON TUBE



5 X 9 MM -
8 X 12 MM - 5 Meter

ACCESSORIES-UROLOGY

PENILE CLAMP INCONTINENCE CLAMP

Used to Control Stress Incontinence

Sizes: 7cm, 9 cm



Penile Clamps are a safe non-invasive procedure that requires no surgery or drugs to treat Male Incontinence. As an external clamp that gently applies pressure to stop urine flow through the urethra, Penile clamps have proven to be effective for men with incontinence

UMBILICAL CLAMP



MONOFILAMENT POLYPROPYLENE MESH

Urinary incontinence mesh has 2 fixation arms. Tissue healing process is enhanced.

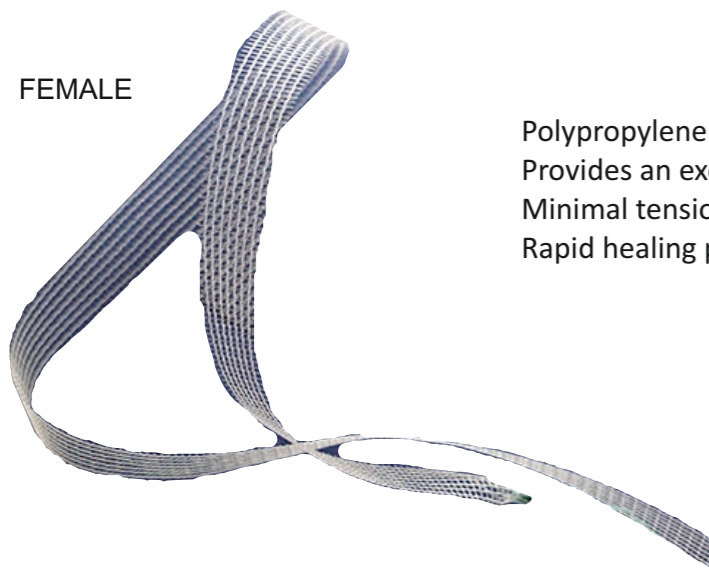
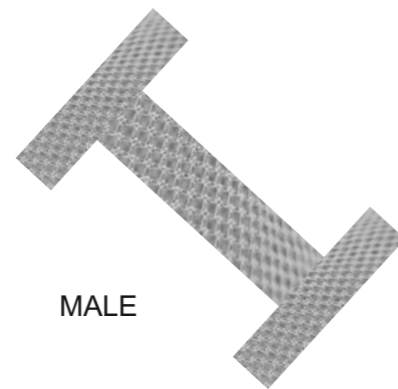
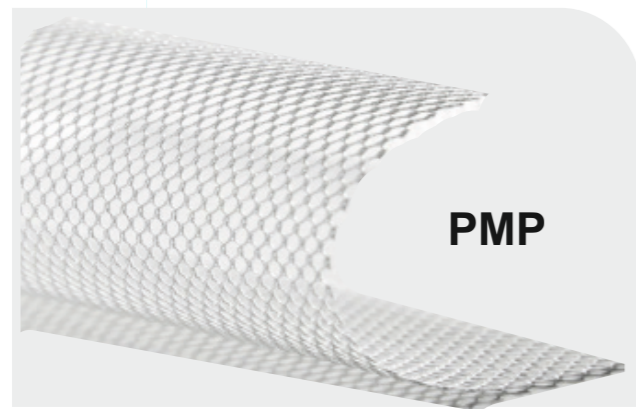

Polypropylene monofilament
Provides an excellent urethral closure
Minimal tensioning and Invasive
Rapid healing process

